

auto electrical parts

Technical Information Sheet

Part No. 0-668-95

Durite Interior Lamp. SMD 2525 LED's
10-30VDC. 134 white SMD LED's.
PC Lens with ADC12 Housing. IP67. E
Marked EMC R10. 20cm flying leads. Current
Draw 1.1A @ 12VDC, 0.6A @ 24VDC.



Technical Drawing (not to scale)

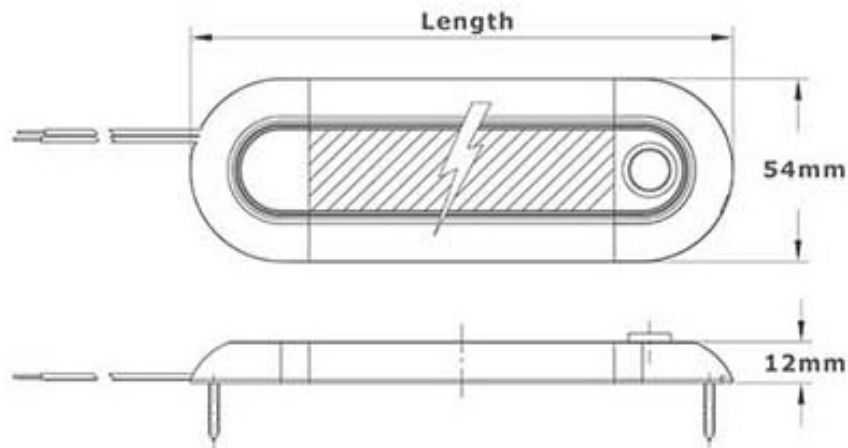

Specification

Type	Linear LED Interior Lamp
Voltage	10-30VDC
LED	134 x 0.2W
Power	23.6W
Illumination	820 Lumens
Lux @ 1 Meter	223 Lux
Material	PC Lens, ADC12 Housing
Protection	IP67
Operating Temperature	-25°C to 65°C
Switch	N/A
Dimensions	600*54*12mm
Compliance	CE, EMC R10

The information contained in this document is correct to the best of our knowledge at the time of printing. However, specifications may change at any time without notice.